

# Dual

# 1212

## INSTRUCTIONS FOR INSTALLATION AND OPERATION



**Auto/Standard Turntable**

It is customary at this point to congratulate the owner on his wise choice and to urge him to read the instructions carefully before going any further into the unpacking and assembly. We certainly do both. As you, are obviously already convinced that the DUAL 1212 was your wisest choice, there is no need for us to throw any further bouquets. However, in addition to the instructions themselves, you will find descriptions

of the Dual's more exceptional features for your further enlightenment and "pride of ownership." Before you turn your attention to them, we suggest you read these instructions carefully and in their proper sequence. This will assure maximum satisfaction and appreciation of the advanced caliber of performance made possible by this outstanding automatic turntable.

# Dual 1212

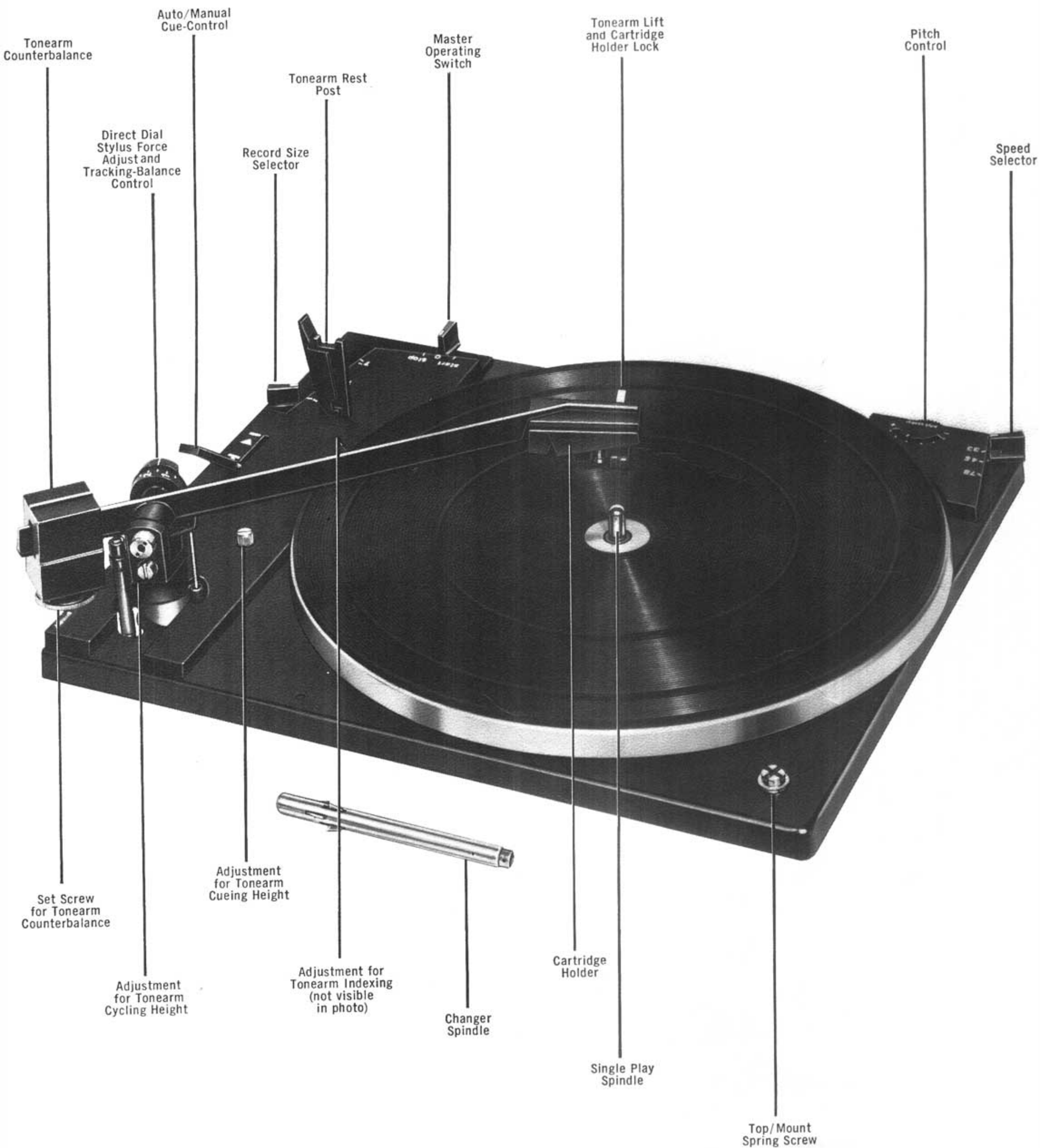



# OPERATING INSTRUCTIONS

## Master Operating Switch

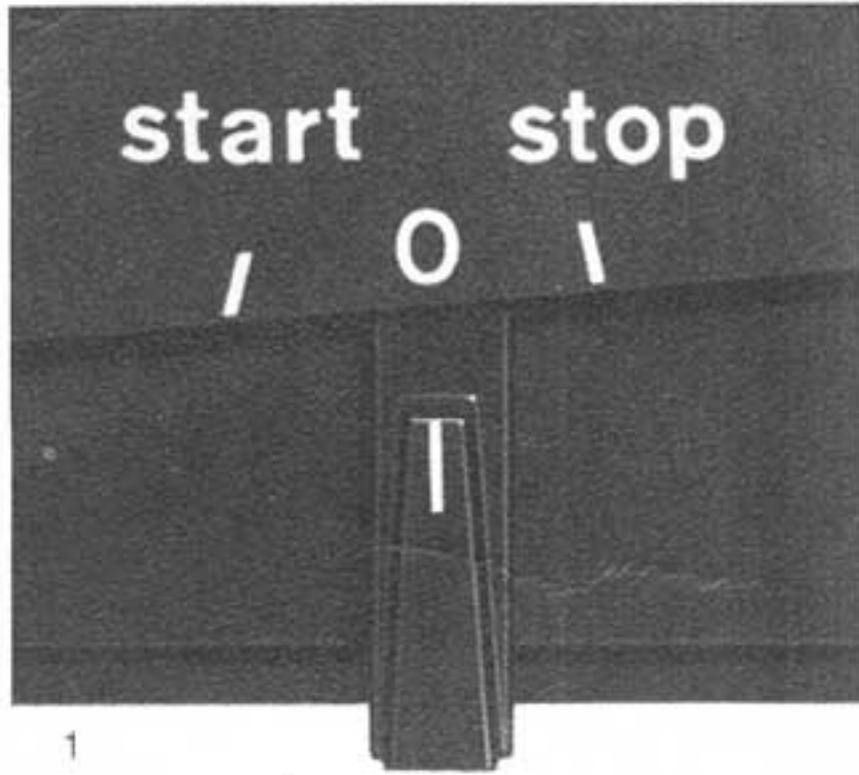



This one feathertouch slide switch controls all operating functions, in both single play and changer operation, as described below.

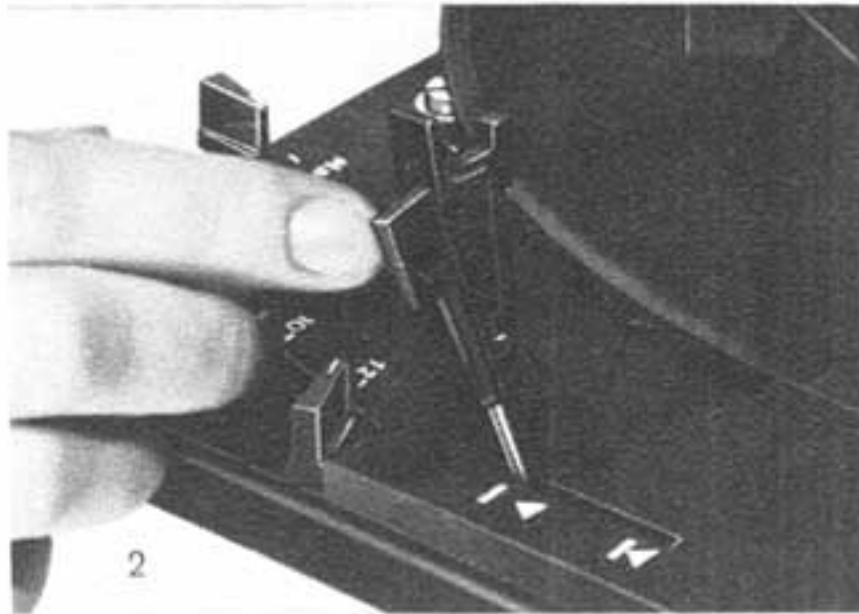

## Preparations for Play

Select the correct speed and record indexing size for the record to be played, then insert either the short spindle (for single play) or the long spindle (for changer operation).



## Using the Cue-Control

The Cue-Control has two positions:  to lift the tonearm, and  for lowering it. (Fig. 2) To lower the tonearm to any groove, you need give only the lightest flick to the Cue-Control. (The descent of the tonearm is immediately taken over by silicon damping and a piston action. Lowering speed is 0.5 cm/second, and is unaffected by temperature or humidity changes.)

To raise the tonearm, on the other hand, you do control the rate of ascent by the speed with which you move the Cue-Control from position  to position .

## With Automatic Start Too!





The Cue-Control can also be used together with automatic start for a slower-than-normal rate of descent, as may be desired with ultra-high compliance styli. Once the cycling action has placed the tonearm over the lead-in groove and it begins to descend, then Cue-Control takes over. The Cue-Control itself is automatically shifted to position , where it is ready to raise the tonearm at any time during play.

## Variable Cueing Height

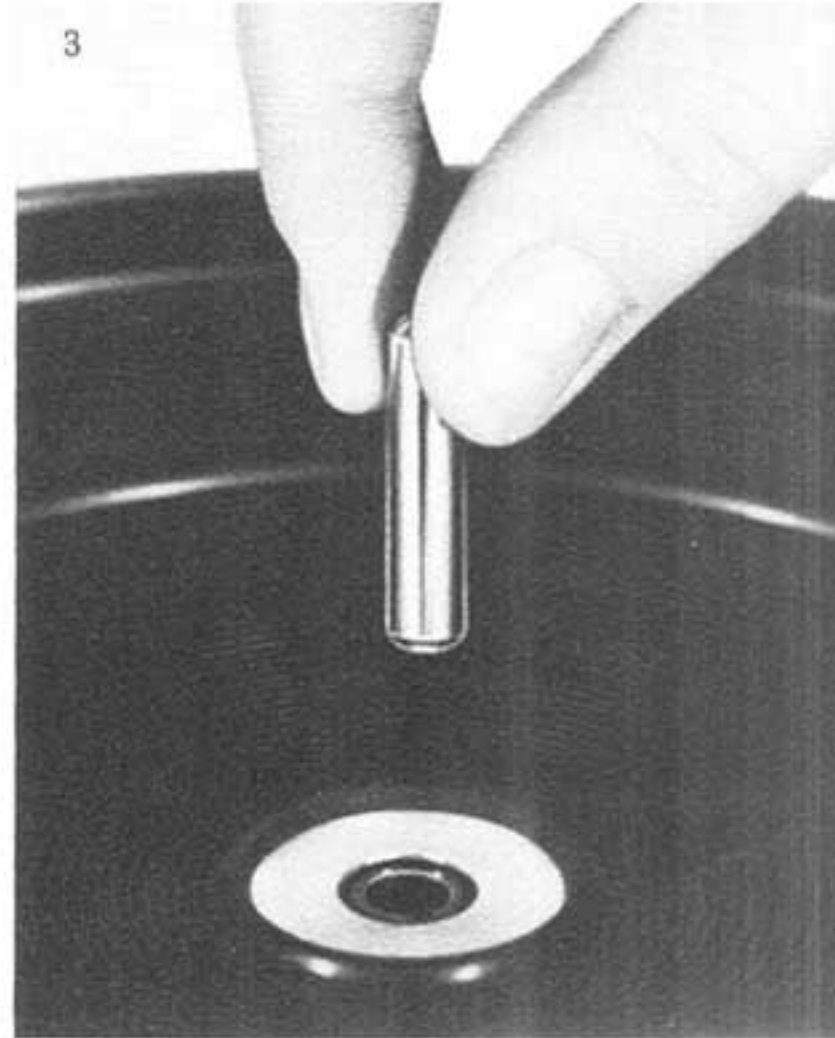
The height of the stylus above the record from which the Cue-Control lowers the tonearm has been pre-set for the average cartridge depth. This height can be varied over a 1/4" (6mm) range by means of the adjustment screw located on the chassis in front of the tonearm pivot. Turning this screw counterclockwise reduces the height, turning it clockwise increases the height.

## Single Play



- 1. Automatic Start:** move the slide switch to START.
  - 2. Automatic Start with Cue-Control.** First move Cue-Control to position , then move slide switch to START. (This provides an even more gradual tonearm descent, as sometimes preferred for ultra high compliance cartridges.)
  - 3. Manual Start (on rotating record):**
    - a. Lift tonearm and move it toward the record. (This will start the record rotating.)
    - b. Place tonearm on record.
  - 4. Cue-Control (on rotating record):**
    - a. Move Cue-Control to position .
    - b. Place tonearm over lead-in groove (or over any other groove).
    - c. Flick Cue-Control to position .
  - 5. To stop play:** (tonearm returns to rest, motor shuts off).  
Push to STOP.
  - 6. To interrupt play and replay from beginning:**  
Push gently to STOP, pause, then continue to START.
  - 7. To interrupt play:** (when play is to be resumed where interrupted).  
Move Cue-Control to position .
  - 8. To resume play:**  
Flick Cue-Control to position .
- Note: at the end of play, the tonearm will return to its resting post and the entire machine will shut off automatically.

## Automatic Changer Operation

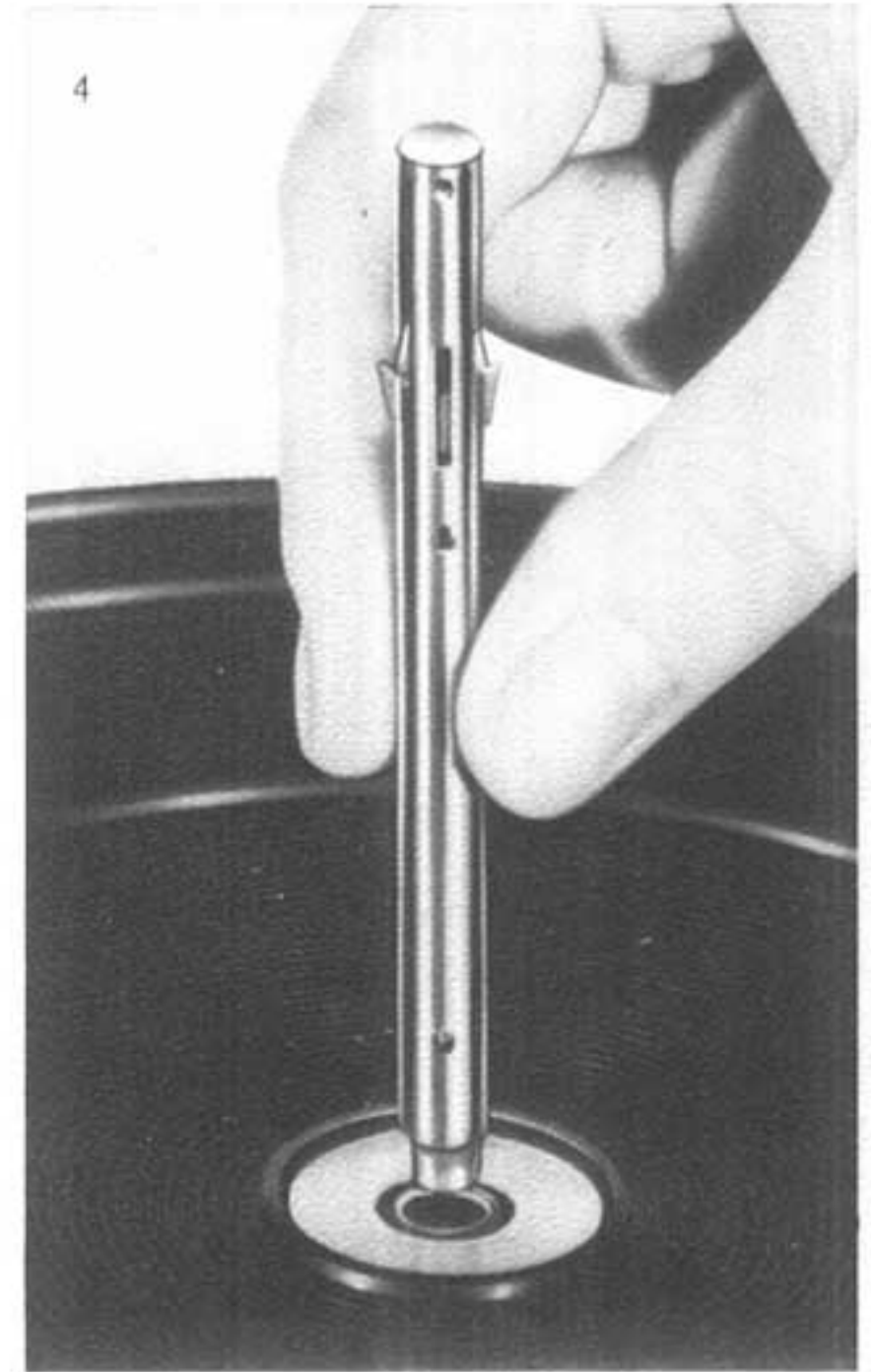

Insert the changer spindle by placing the key at its base into the slot of the shaft. Then turn the spindle clockwise until it stops. Up to six records can be placed on the spindle.

If the changer spindle is not seated properly, the next record will not drop, and the tonearm will simply return to its resting post after play. If this happens, turn the spindle clockwise until it stops.

All the functions for single play, as described above, are exactly the same in changer operation, plus these additional functions:

- 1. To reject a record during play and change to the next record on the spindle:**  
Push gently to STOP, pause, then continue to START.
- 2. To skip the next record on the spindle:**  
Push to STOP. After that record drops, push to START and the next record will drop.

Note: Any record already on the platter, can be replayed either automatically or manually, just as with the single play spindle. If there are any records on top of the one you wish to replay, simply lift them back onto the platter or off the spindle. (The 3-pronged platform will retract into the spindle as the records slip past.) No need to remove the spindle itself.

## Jamproof Tonearm

During either single play or changer operation, the tonearm can be lifted from the record, moved and placed down again either by hand or by the Cue-Control. The tonearm may even be restrained during cycling without causing any malfunction... thanks to its foolproof slip-clutch.



# INSTALLATION\* INSTRUCTIONS

REQUIRED DIMENSIONS: 13" width; 10 1/2" depth; 5" height above base, 2 5/8" below.

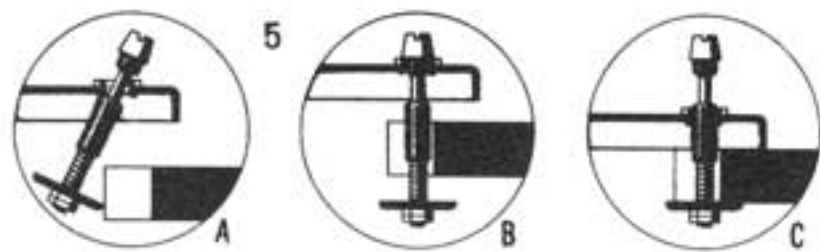

## Mounting On Base

These ingeniously designed mounting screws make it possible to install (and remove) your Dual on either base or mounting board entirely from the top. There's no need to fumble underneath or to take anything apart.

1. Position the chassis over the base so that the three cupped spring-mounted footings will fit into their cutouts. (The notch on the base for the rear top/mount spring screw will then be at the upper left.) Tilt both mounting screws to let them slip past the notches as you lower the chassis. (Fig. 5 a).

2. Turn each screw clockwise until it is firmly seated into the top of the chassis. (Fig. 5 b) That's all there is to it. To remove the Dual, simply reverse the above procedure.

## To Transport the Dual Without Dismounting

1. Loosen both top/mount spring screws, depress the chassis against the base, then continue to turn each screw counterclockwise until it stops. The chassis will then be locked firmly against the base. (Fig. 5 c)

2. To avoid possible damage to the platter bearings in transit, insert the plastic wedges between the platter and chassis. Position the wedges at equal distances for maximum support. Or you can remove the platter from the chassis (See below).

## Mounting the Cartridge\*

NOTE: Any cartridge weighing between 1 and 12 grams and meeting standard U.S. mounting specifications can be used with the Dual.

1. Release the cartridge holder from the tonearm head by pressing the tonearm lift a short turn to the rear. Be ready to catch the holder, as it will drop right into your hand (Fig. 6).

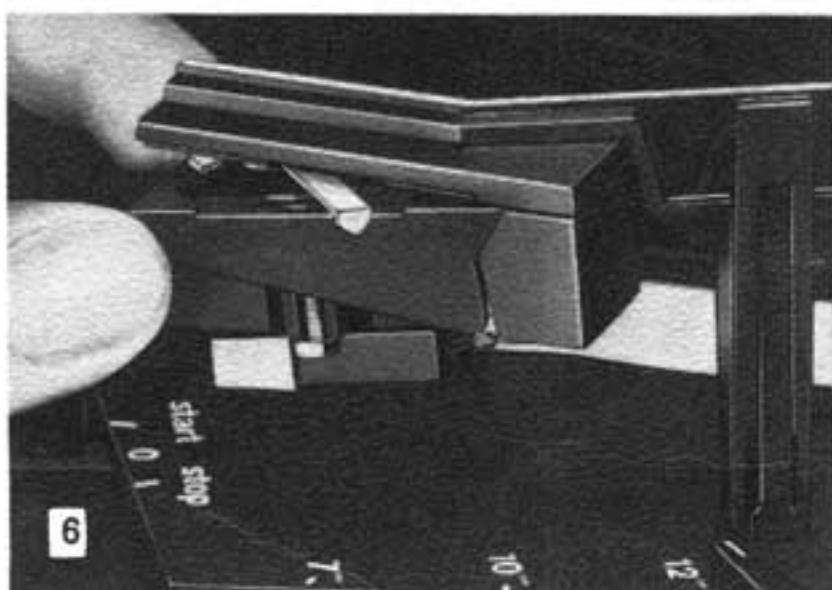

2. The special gauge supplied with your Dual, when snapped onto the holder as shown in fig. 7, will indicate the correct stylus depth for the cartridge when mounted. (Be sure the ridges on the inside of the gauge walls fit into the corresponding tracks on the side of the cartridge holder.)

When the cartridge is mounted at the correct depth, the tip of the stylus will protrude slightly into the notch of the gauge. (Use the necessary spacers and screws provided in the accessory bag.)

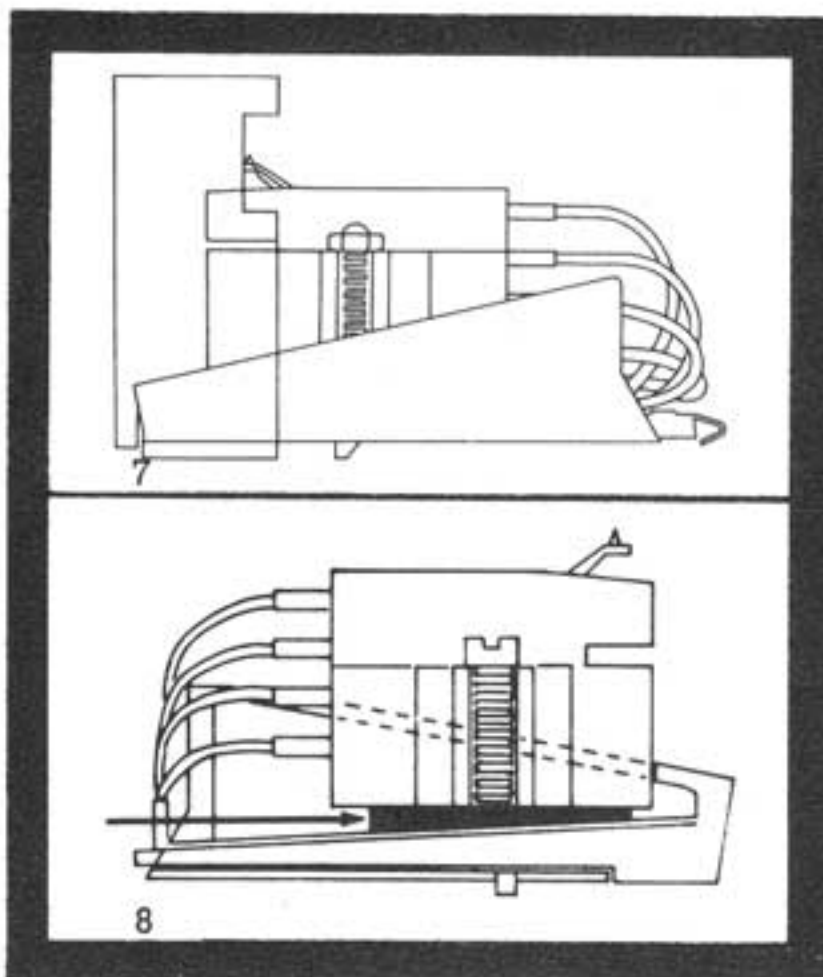

3. The specially tapered wedge, also supplied, is for use when you intend to play single records either exclusively or primarily. (Fig. 8) This wedge provides the optimum 15° vertical tracking angle when one record is on the platter. (However, even without the wedge, the vertical tracking angle will still be well within standard industry tolerances for single record play.)

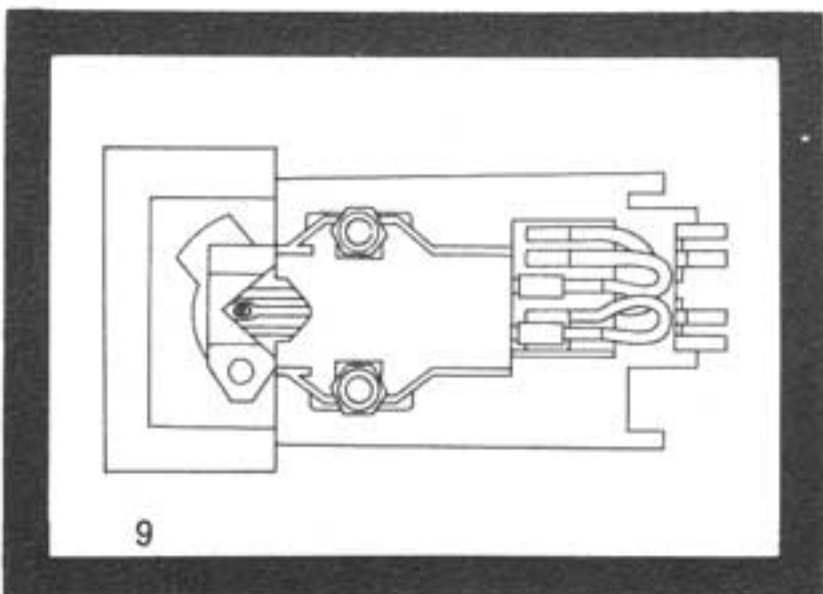

4. Remove the gauge when actually mounting the cartridge, then snap it on again—carefully—to check stylus overhang. When viewed from the top (Fig. 9), the stylus should be centered within the notch of the gauge.

5. Finally, tighten screws, making sure cartridge is positioned straight. Note dotted line in fig. 9.

6. Connect each lead on the cartridge holder to its corresponding pin on the cartridge. Each lead is color-coded as shown in fig. 10.

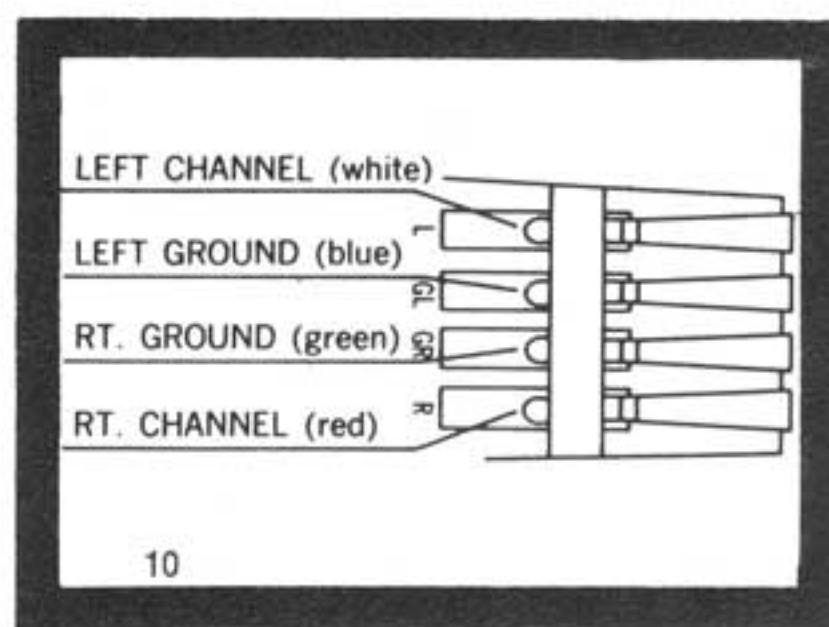

7. Attach the cartridge holder by placing it against the tonearm head as shown in fig. 6., lift it up and lock it by pressing the tonearm lift forward.

## Balancing the Tonearm\*

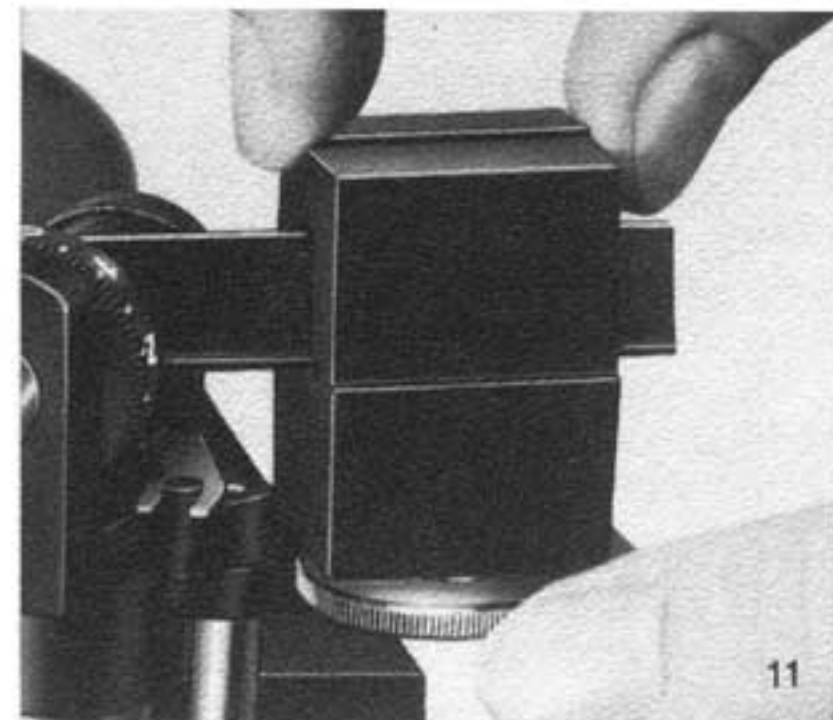

To balance the tonearm for the weight of the cartridge installed in it:

1. Lock the tonearm on its rest post, push the operating switch to START, and rotate the platter by hand two or three times. (This is to be sure the tonearm is disengaged from the automatic mechanism and will be free-floating.)

2. Set the tracking force dial at "0" and loosen the lock-knob of the counterbalance.

3. Unlock the tonearm and move it just to the inside of the rest post. Then note if the tonearm floats either up or down.

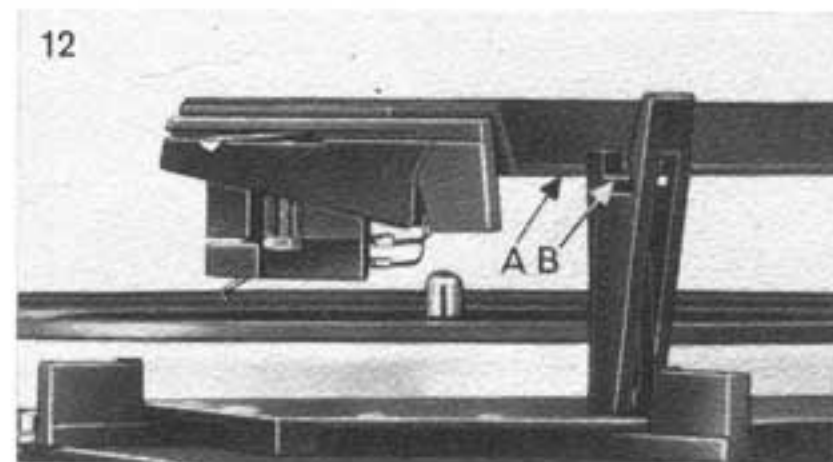

4. To raise the tonearm, slide the counterbalance back. To lower the tonearm, slide the counterbalance forward. (When points A and B as shown in fig. 12 are aligned, the tonearm is perfectly balanced.) Secure the balance by tightening the lock-knob.

As a further confirmation of perfect balance, tap the chassis lightly while the tonearm is floating free. The tonearm should remain virtually motionless even while the chassis is in motion.

\*Instructions for installing on base, mounting cartridge and balancing tonearm apply for Duals purchased as separate components. If your Dual is already mounted within a console, these installation procedures have already been made for you. However, reading these three sections will familiarize you with the unit.



## Applying Tracking Force and Tracking-Balance Control (anti-skating)

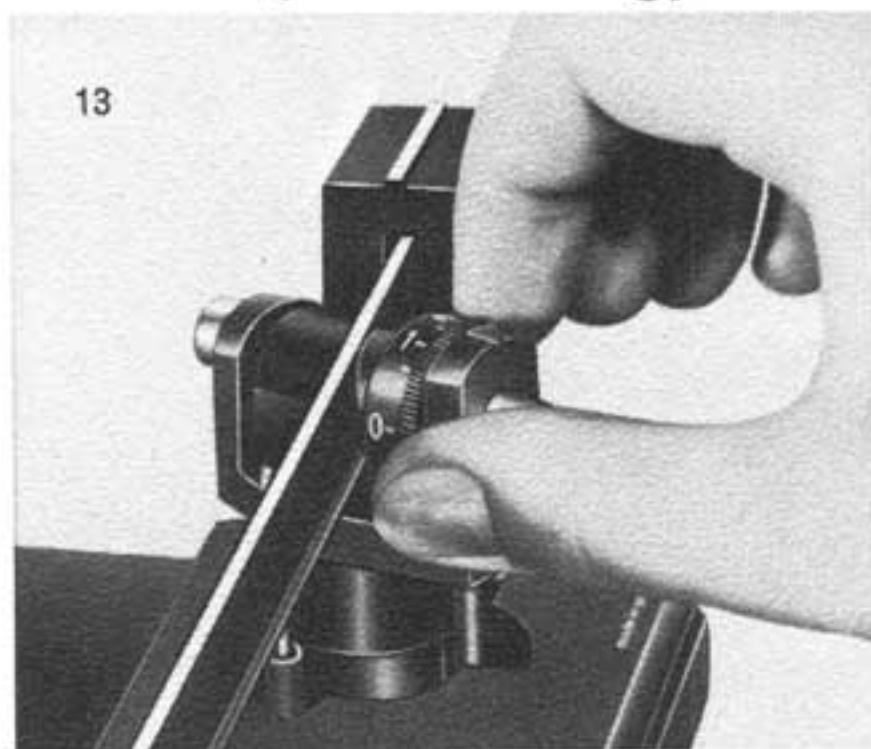

With the tonearm balanced at zero, you now set both tracking force and Tracking-Balance Control simultaneously by turning the calibrated dial to the number you want. This is accurate to within 0.1 gram. (Follow the instructions with your cartridge for the recommended tracking force.)

As the tonearm of the Dual can track flawlessly as low as one gram, the only limitations on tracking force are those imposed by the cartridge itself.

That is why you can use virtually any cartridge you prefer with the Dual, including those with ultra-high compliance styli not ordinarily recommended for use in automatic tonearms.

## Connection to Audio Equipment\*

Use the red cable for left channel and the yellow cable for right channel. If you have a mono amplifier, a "Y" connector, available at most audio dealers, will enable you to combine both channel leads into a single output.

## Connection to Power Supply\*

AC voltage and line frequency (cycles) requirements are indicated on both the outside of the carton and on the top of the chassis beneath the turntable. The Dual can be set to either 110 VAC or 220 VAC, and for line frequency of either 50 or 60 cycles. The 60 cycle pulley is Part Number 12V-U22, the 50 cycle pulley, Part Number 12V-U16. Only a qualified serviceman should attempt to make either of these changes.

## Adjustment for Lead-in Groove

The tonearm has been set to descend accurately into the lead-in groove. But if the dimensions of your cartridge and/or the location of its stylus cause the latter to touch the record either too far in or too far out, it can be adjusted quite easily.

Move the record-size selector to the 7" position, thus exposing the indexing adjustment screw. If the stylus touches the record outside the lead-in grooves, turn the screw clockwise; and vice versa. A very slight turn will suffice in either case.

Any size record can be used to check the adjustment, as once set for one size, it will be correct for all.

## Removing the Platter

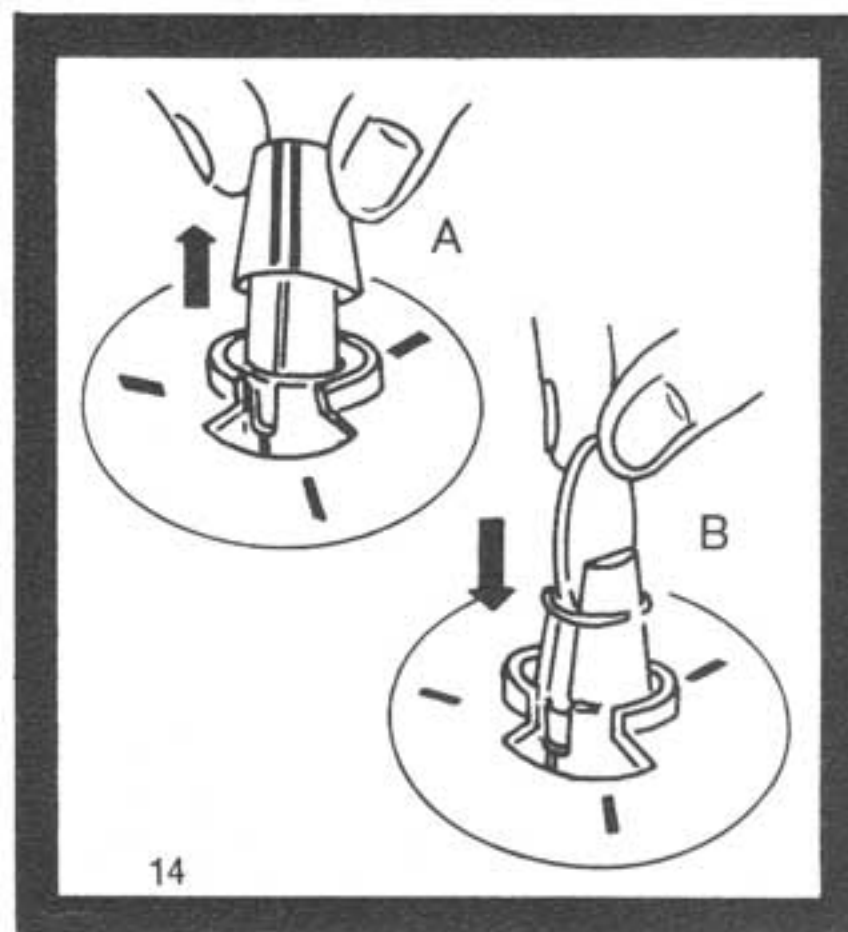

The platter is secured to the chassis by a spring-clip around the groove of the shaft. To remove the platter, use the special accessory cone supplied in the bag with the cartridge mounting hardware. Remove the spring clip as shown in Fig. 14 a. Then lift the platter slowly and gently off the shaft. Avoid touching the inner surfaces with your fingers, as skin oils can induce slippage.

Reverse these procedures when replacing the platter. The same accessory is used to secure it with the spring clip. As shown in Fig. 14 b, press the spring-clip all the way down with the use of a coin until it is again seated in the groove.

### Master Power Control for Amplifier Shut-off

Your Dual is equipped with a unique provision for controlling the power to the amplifier, so that the entire system can be switched on and off automatically by the turntable. This is suggested for use only with transistor units, as they do not require any warm-up time. To take advantage of this special feature (which handles up to 400 VA), consult your Dual dealer or a qualified serviceman, in accordance with UL requirements. When used with a receiver, we suggest an external on-off switch be included, so that the tuner section can be used without operating the turntable.

## SPECIAL OPERATING FEATURES OF YOUR DUAL 1212

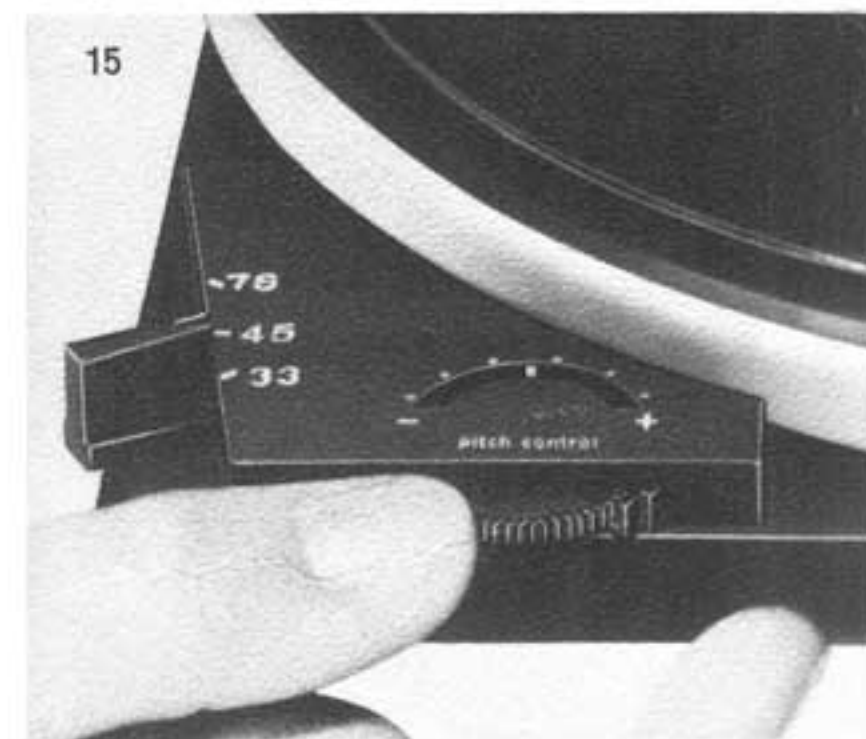

### Variable Pitch-Control™

Each of the three standard speeds (33 $\frac{1}{3}$ , 45, 78 rpm) can be varied over a 6% range with the vernier Pitch-Control. This opportunity to change pitch by more than a half note is especially valuable to serious music listeners, students, those recording onto tape, and every perfectionist.

Whenever you set the Pitch-Control, speed will remain absolutely constant. (You can check it yourself with the strobe disc supplied.)

Slide the cover open when operating the Pitch-Control, then close it to prevent accidental shifting.

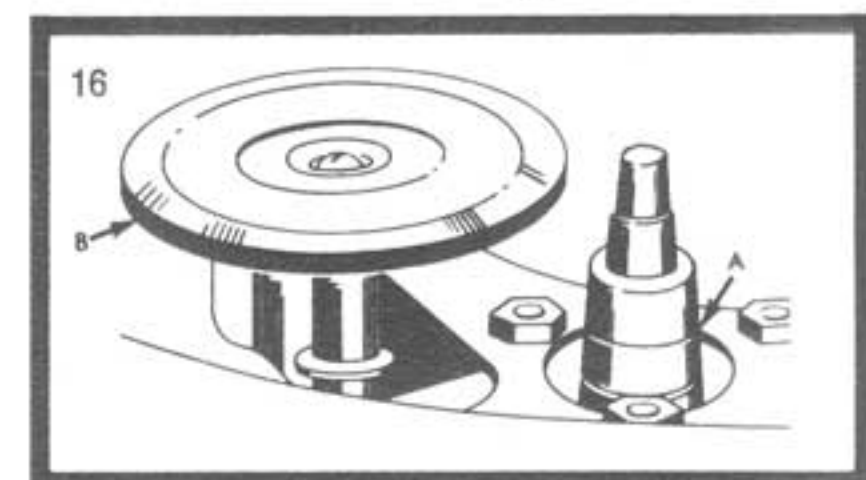

### How the Pitch-Control Works

This has been achieved by a simple and foolproof method that does not change or affect motor speed or power in any way. The motor drive pulley (A) has three precisely tapered sections, one for each speed, as shown in Fig. 16. The idler wheel (B) is positioned at one of these sections by the speed selector switch. Then the idler wheel is raised and lowered along the section by the Pitch-Control. The motor drive pulley and the idler wheel disengage automatically after play, thus preventing any possibility of flat spots developing on the idler.

Cont'd on page 6



## Tracking-Balance Control (anti-skating)

### What You Should Know About Skating

Skating refers to the side-thrust imparted to the stylus from the offset angle of the tonearm head and the friction between the stylus and the rotating record.

This causes the stylus to "skate" toward the center of the record, thus causing increased force against the inner groove and correspondingly less force against the outer groove. This results in distortion, increased wear on the inner groove and uneven wear on the stylus itself.

Skating is actually not a serious problem with ordinary tonearms, as their bearing friction in the pivot is generally high enough to cancel out or minimize the tendency to skate. Of course, bearing friction high enough to prevent skating is also high enough to compromise tracking performance at the ultra-lightweight forces now made possible by today's finest high compliance cartridges.

The amount of skating force is directly measureable, and amounts to about 12% of tracking force. Fig. 17 illustrates the physical principle behind skating and the forces that cause it.

A tonearm with 2 gram tracking force will thus have a potential skating force of .24 grams. We say potential, since, as noted above, if a tonearm's bearing friction is above .24 gram, it won't skate.

The horizontal bearing friction of the Dual tonearm, on the other hand, is lower than 0.1 gram. Thus, Tracking-Balance Control of the same high order of precision—and with continuously variable control—was one of our major goals and achievements.

### Actual Forces Present at Stylus Point

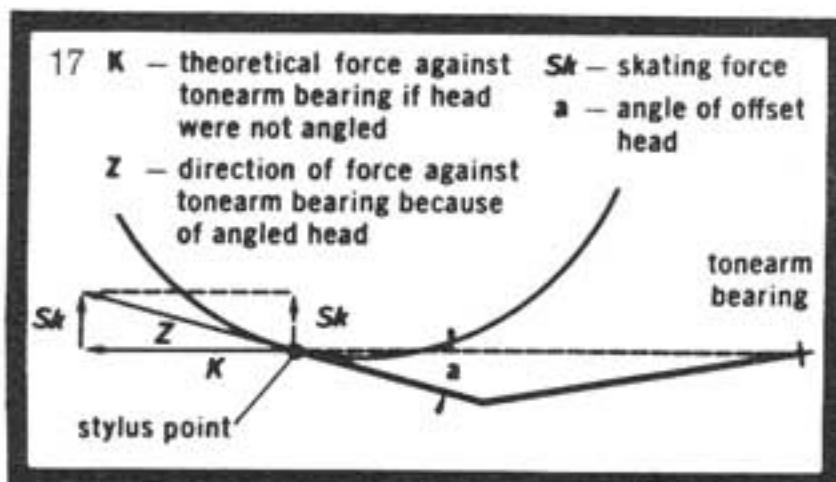

### How Tracking-Balance Control Is Applied



When you set tracking force on the Dual with a continuously variable direct-reading dial, Tracking-Balance Control for that same force is also set simultaneously by a special direct coupling. Tracking-Balance Control is calibrated for the most commonly used round stylus radius (0.6 mil) and is also sufficiently accurate for other stylus radii as well.

This means that for the first time you can actually balance stylus force on both walls of the stereo groove!

All this is one more example of how Dual assures you of the best possible performance from any cartridge/stylus combination.

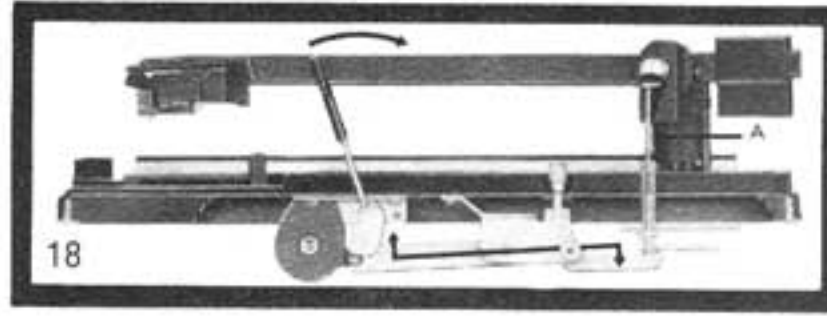
## Auto/Manual Cue-Control™



Cue-Control is shown at position , with tonearm supported by piston (A). When Cue-Control is shifted to position , the piston is released and permits tonearm to slowly lower to record. At this point, the tonearm is completely disengaged from the Cue-Control.

### Precise Stylus-to-Groove Cueing

With the Auto/Manual Cue-Control, still another measure of flexibility and precision has been added to the unrestricted automatic and manual play that has long been available in all Dual automatic turntables.

The Cue-Control makes it possible to pre-position the stylus over any groove and then lower it with absolute accuracy into that very same groove. You can also play to any point, interrupt with the Cue-Control, and resume play where you left off.

A close look at the stylus as it descends will show how the vertical piston action of the Cue-Control mechanism lowers the tonearm with no side-shift whatever, regardless of portion of the record being played.

You will also notice how the silicon damping slows the descent of the tonearm... a far more gentle descent than would ever be possible by hand.

## Powerful Constant-Speed Hi-Torque™ Motor

Of entirely new design, the Dual's powerful and utterly quiet Hi-Torque motor effortlessly brings the heavy turntable to full speed virtually instantaneously. The rotor is dynamically balanced in both planes. Together with the evenly and precisely distributed poles, this eliminates at the source, one of the major sources of rumble and assures speed constancy.

All three speeds are accurate within 0.1%, with one to ten records. Further voltage variations can exceed  $\pm 10\%$  with no effect on speed whatever! Thus the Hi-Torque motor combines the advantages of the induction and synchronous motors.

## Featherlight Tripping

The tripping action is accomplished by a lightweight glider which rides freely on a ball bearing toward the center as the tonearm approaches the run-out grooves. When the stylus reaches these grooves, the glider is brought into featherlight contact with the free-suspension trip switch, and the automatic trip immediately takes over. Less than 0.4 gram force is sufficient to activate the switch.

## Acoustic Feedback Eliminated

The only vibrations induced upon the stylus should be those originating from the recorded grooves. Any others, such as those present in the speakers, must be isolated from the stylus, or it will repeatedly transmit those spurious signals throughout the system—as "acoustic feed-back."



Dual has taken extraordinary care in eliminating anything that would tend to induce acoustic feedback. For example, the spring-mounted footings (Fig. 19) are internally cushioned with rubber between springs and caps. Further, the springs themselves are "soft," because the feathertouch side-to-side action of the operating slide switches do not require stiff vertical resistance.

And the motor, of course, is thoroughly insulated against both shock and vibration. These are some of the "inside" reasons by you will find Dual automatic turntables in the highest quality single-cabinet consoles that can reproduce the full frequency response range without concern for acoustic feedback.

## SERVICING

If your Dual ever requires servicing, ask your Dual audio dealer for the address of the nearest Authorized Dual Service Station. Be sure that authentic Dual parts are used wherever replacement is necessary. Always ship the Dual in its original packaging, or if it has been discarded, write for special shipping instructions.

For correspondence only:

**UNITED AUDIO PRODUCTS, INC.**  
535 Madison Ave., New York, N.Y. 10022

For shipment of merchandise:

**UNITED AUDIO PRODUCTS, INC.**  
56-08 37th Ave., Woodside, N.Y. 11377